

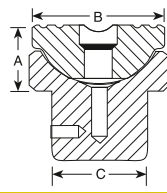

Accessories

Swivel Caps Center Hole Accessories

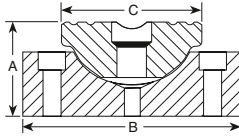

CYLINDERS

SWIVEL CAPS FOR "RSS",					
Use with	Swivel Cap	Weight	A	B	C
RSS101	350320	0,2	25,4	36,5	36,5
RSS202	350321	0,6	34,9	54	54
RSS302	350322	0,7	34,9	63,5	54
RSS502	350331	1,2	36,5	82,6	54
RSS1002	350332	3,0	46	111,1	85,7
Tonnage		"RA" Cylinders			
55	350376	0,9	31,8	71,4	71,4
100	350984	2,5	49,2	95,3	79,4

SWIVEL CAPS FOR "RD" CYLINDERS					
Cylinder	Swivel Cap	Weight	A	B	C
10	350144	0,4	22,2	36,5	21,8
25	350145	0,6	28,6	54	36,5
55	351325	1,9	61,9	63,5	39,3
100	351324	5,1	75,0	95,3	67,5
150	351334	5,8	66,7	111,1	77,8

For use with "RC" cylinders			SWIVEL CAPS Reduce the effects of off center loading. Tilts up to 5 degrees. Radial grooves on top of cap reduce load slippage.			For use with "RL" cylinders			
Use with Cyl. No.	Swivel Cap Order No.	Weight (kg)	A (mm)	B (mm)	A (mm)	B (mm)	Use with Cyl. No.	Swivel Cap Order No.	Wt. (kg)
150-200 ton	420867	4,0	38,1	130,2	25,4	71,4	55-100 ton	420866	0,8
280 ton	420868	6,1	44,5	149,2	38,1	130,2	150-200 ton	420867	4,8
355 ton	420869	16,8	69,9	195,3	44,5	149,2	280 ton	420868	6,1
435 ton	420870	23,6	79,4	225,4	69,9	195,3	355 ton	420869	16,8
565 ton	420871	35,4	92,1	250,8	79,4	225,4	435 ton	420870	23,6
					92,1	250,8	565 ton	420871	35,4

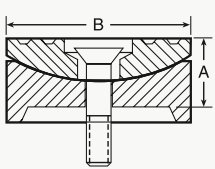

Reduce the effects of off center loading. Tilts up to 5 degrees. Radial grooves on top of cap reduce load slippage. Notch across face of each cap helps keep loads having a protruding or round shaped centered.

"CENTER-HOLE" CYLINDER ACCESSORIES					
To use with Cyl. No.	RT172, RH203	RT302, RH302 RH303, RH306	RT503, RH503, RH603 RH605, RH606	RT1004	
Order Set No.	RHA20	RHA30	RHA50	RHA100	
1 Speed Crank	1	24814	27198	29595	303785
2 Speed Nut	2	302482	302483	33439	34136
3 Adjusting Screw	3	32118	34758	32698	32699
		1"-8 508 mm Lg.	1 1/4"-7 x 609,6 mm Lg.	1 5/8"-5 1/2" x 762 mm Lg.	2 1/2"-8 x 869,9 mm Lg.
4 Threaded Insert	4	Order threaded insert for RH series cylinders with the accessory set.(See page 36/37) Threaded insert supplied with RT series cylinders.			
5 Pushing Adapter	5	201923	34510	34755	-
		1"-8, 12,7 mm dia. shank	1 1/4"-7 x 19,1mm dia. shank	1 5/8"-5 1/2" x 25,4 mm dia. shank	
6 Pushing Adapter	6	201454	34511	34756	-
		1"-8, 19,5 mm dia. shank	1 1/4"-7 x 25,4 mm dia. shank	1 5/8"-5 1/2" x 31,7 mm dia. shank	
7 Jack Screw	7	24813	25931	32701	32702
		1"-8 x 177,8 mm Lg.	1 1/4"-7 x 228,6 mm Lg.	1 5/8"-5 1/2" x 279,4 mm Lg.	2 1/2"-8 x 406,4 mm Lg.
8 Screw Cap	8	28228	28229	28230	-
		1"-8 x 38,1 mm dia.	1 1/4"-7 x 44,4 mm dia	1 5/8"-5 1/2" x 57,2 mm Lg.	

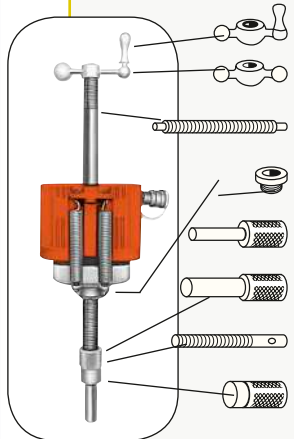



Accessories

Seal Kits

Cylinder Order No.	Seal Kit*	Viton Seal Kit
C51C	300404	300210
C53C	300404	300210
C55C	300404	300210
C57C	300404	300210
C59C	300404	300210
C101C	300116	300211
C102C	300116	300211
C104C	300116	300211
C106C	300116	300211
C108C	300116	300211
C1010C	300116	300211
C1012C	300116	300211
C1014C	300116	300211
C1016C	300116	300211
C151C	300453	300471
C152C	300453	300471
C154C	300453	300471
C156C	300453	300471
C158C	300453	300471
C1510C	300453	300471
C1512C	300453	300471
C1514C	300453	300471
C1516C	300453	300471
C251C	300147	300213
C252C	300147	300213
C254C	300147	300213
C256C	300147	300213
C258C	300147	300213
C2510C	300147	300213
C2512C	300147	300213
C2514C	300147	300213
C552C	300114	300215
C554C	300114	300215
C556C	300114	300215
C5510C	300114	300215
C5513C	300114	300215
C756C	300647	300846
C7513C	300647	300846
C1002C	300112	300216
C1006C	300112	300216
C10010C	300112	300216
C55CBT	300404	300210
C106CBT	300116	300211
C1010CBT	300116	300211
C256CBT	300147	300213
C2514CBT	300147	300213
R1502C	300676	—
R1506C	300676	—
R15010C	300676	—
R2002C	300677	—
R2006C	300677	—

Cylinder Order No.	Seal Kit*	Viton Seal Kit
R20010C	300677	—
R2802C	300678	—
R2806C	300678	—
R28010C	300678	—
R3552C	300679	—
R3556C	300679	—
R35510C	300679	—
R4302C	300680	—
R4306C	300680	—
R43010C	300680	—
R5652C	300681	—
R5656C	300681	—
R56510C	300681	—
R1002D	300928	—
R1006D	300928	—
R10010D	300928	—
R1502D	300929	—
R1506D	300929	—
R15010D	300929	—
R2002D	300930	—
R2006D	300930	—
R20010D	300930	—
R2802D	300931	—
R2806D	300931	—
R28010D	300931	—
R3552D	300932	—
R3556D	300932	—
R35510D	300932	—
R4302D	300933	—
R4306D	300933	—
R43010D	300933	—
R5652D	300934	—
R5656D	300934	—
R56510D	300934	—
R552L	300674	—
R556L	300674	—
R5510L	300674	—
R1002L	300675	—
R1006L	300675	—
R10010L	300675	—
R1502L	300676	—
R1506L	300676	—
R15010L	300676	—
R2002L	300677	—
R2006L	300677	—
R20010L	300677	—
R2802L	300678	—
R2806L	300678	—
R28010L	300678	—
R3552L	300679	—
R3556L	300679	—

Cylinder Order No.	Seal Kit*	Viton Seal Kit
R35510L	300679	—
R4302L	300680	—
R4306L	300680	—
R43010L	300680	—
R5652L	300681	—
R5656L	300681	—
R56510L	300681	—
RA202	300631	—
RA204	300631	—
RA206	300631	—
RA302	300632	—
RA304	300632	—
RA306	300632	—
RA552	300391	—
RA554	300391	—
RA556	300391	—
RA5510	300391	—
RA1002	300444	—
RA1006	300444	—
RA556L	300395	—
RA1006L	300396	—
RD106	300017	—
RD1010	300017	—
RD256	300118	—
RD2514	300118	—
RD556	300005	—
RD5513	300005	—
RD5518	300005	—
RD8013	300410	—
RD1006	300006	—
RD10013	300006	—
RD10020	300006	—
RD1506	300007	—
RD15013	300007	—
RD15018	300007	—
RD2006	300008	—
RD20013	300008	—
RD3006	300466	—
RD30013	300466	—
RD4006	300467	—
RD40013	300467	—
RD5006	300468	—
RD50013	300468	—
RH102	300071	300221
RH108	300071	300221
RH120	300657	—

Cylinder Order No.	Seal Kit*	Viton Seal Kit
RH121	300576	—
RH121T	300576	—
RH123	300576	—
RH202	300615	—
RH203	300069	300222
RH206	300615	—
RH302	300037	300223
RH306	300037	300223
RH503	300059	300225
RH603	300477	300476
RH606	300477	300476
RH1003	300485	300585
RH303	300077	300224
RH306D	300822	300224
RH3010	300625	—
RH605	300269	300226
RH6010	300626	—
RH1001	300927	—
RH1006	300295	300227
RH10010	300629	—
RH1505	300154	300228
RH1508	300583	—
RH2008	300582	—
RHA306	300867	300868
RHA604D	300269	300226
RLS50	300454	—
RLS100	300455	—
RLS200	300456	—
RLS300	300457	—
RLS500S	300458	—
RLS750S	300459	—
RLS1000S	300460	—
RLS1500S	300461	—
RP25	300628	—
RP55	300627	—
RSS101	300010	—
RSS202	300011	—
RSS302	300297	—
RSS502	300292	—
RSS1002	300293	—
RSS2503	—	—
RSS1002D	300578	—
RT172	300358	—
RT302	300359	—
RT503	300360	—
RT1004	300024	—

* Nitrile seals come standard on all cylinders.

CYLINDERS



Accessories

Cribbing Blocks

CYLINDERS

Convert Power Team “Shorty” cylinders to mechanical cribbing devices; more stable than timber or other awkward, makeshift methods. Ideal for lifting applications such as structure moving. Reduce cribbing time dramatically. In effect, increases the stroke of the cylinder; stacking pads act as cylinder extensions:

1. Extend cylinder and insert lower supporting ring.
2. Retract cylinder, insert a stacking pad.
3. Extend cylinder again; pad increases cylinder stroke.
4. Repeat process until all rings and pads are used.

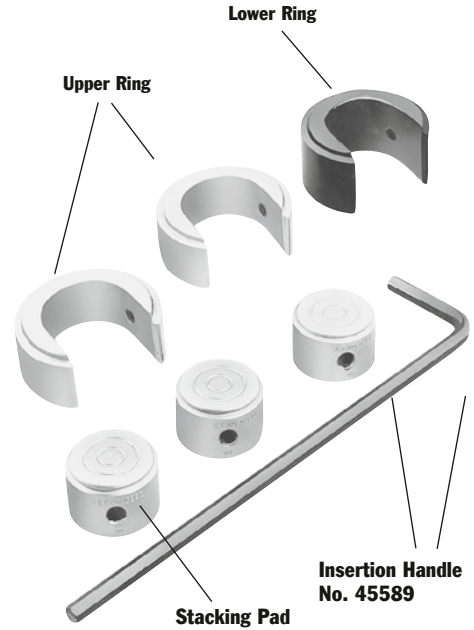

Each cribbing block set includes rings, pads and insertion handle.

- No. CB30 – Cribbing block set for use with No. RSS302; 30 ton cylinder.
- No. CB50 – Cribbing block set for use with No. RSS502; 50 ton cylinder.
- No. CB100 – Cribbing block set for use with No. RSS1002; 100 ton cylinder.
- No. 45589 – Insertion handle is used for inserting rings and pads.

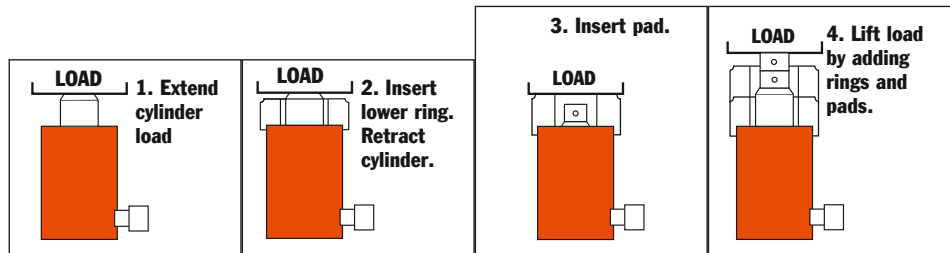

FOR USE WITH ORDER NUMBER	30 TON CYLINDER NO. RSS302 30 TON SET NO. CB30			50 TON CYLINDER NO. RSS502 50 TON SET NO. CB50			100 TON CYLINDER NO. RSS1002 100 TON SET NO. CB100		
	Lower Ring	Upper Ring	Stacking Pad	Lower Ring	Upper Ring	Stacking Pad	Lower Ring	Upper Ring	Stacking Pad
No. included in set	1	2	3	1	2	3	1	2	3
Outside Diameter (mm)	114,3	114,3	69,9	139,7	139,7	85,7	187,7	187,7	120,7
Inside Diameter (mm)	71,4	71,4	—	87,7	87,7	—	122,2	122,2	—
Height, each (mm)	57,9	45,6	45,2	56,4	43,7	42,8	54	44,5	43,7
Total stacked height of rings in Set (mm)	138,1			131,7			174,6		
Weight of Set (kg)	9,1			12,7			29		

Each set includes one Insertion Handle No. 45589 - 1/2" Hex. x 18" Long, 4" Bend



Accessories

Cylinder

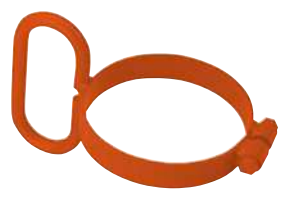

- CYLINDER LIFTING HANDLE**
- No. 4206550R9** – Lifting handle for “C” series, 25 ton cylinders.
 - No. 4213120R9** – Lifting handle for RH302, RH303, RH306 and RH306D, cylinders.
 - No. 252215** – Lifting handle RHA306, 30 ton cylinder.
 - No. 420496BK2** – Lifting handle RA552 and RA554, 55 ton cylinders.
 - No. 420498BK2** – Lifting handle RA1002, 100 ton cylinder.

ALUMINUM CYLINDER BASE

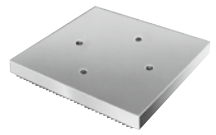

Aluminum Cylinder Base – For use when an enlarged cylinder base is needed or advantageous. Attaches to bottom of RA556, RA556L and RA5510 with four 3/8”-16 screws (included). Serrated base for extra stability.

No. 208406 – Aluminum cylinder base, 317 cm². For use with RA556, RA556L and RA5510 cylinders.



Quick-Change Inserts

HEAD INSERTS FOR RH SERIES CYLINDERS

For Use With:	Threaded Insert Order No.
RH102, RH108	28632 3/4”-16
RH203	28612 1”-8
RH302, RH306	38904 1 1/4”-7
RH303	28644 1 1/4”-7
RH503	38855 1 5/8”-5 1/2
RH603, RH605	34251
RH606	1 5/8”-5 1/2

“QUICK CHANGE” HEAD INSERTS FOR RT SERIES CYLINDERS

For Use With:	Threaded Order No.*	Plain Order No.
RT172	21669	21714
RT302	21873	21872
RT503	22274	22275
RT1004	24197	24196

Switch from a tapped hole to a plain hole quickly with these cylinder head inserts. They are held in place with a socket screw. Plain hole permits use of a speed nut for readjusting cylinder after extension.

* Provided with cylinder

CYLINDERS